

High Linearity SQIF-like Josephson-Junction Structures

Victor K. Kornev, Igor I. Soloviev, Nikolai V. Klenov, and Oleg A. Mukhanov, *Senior Member, IEEE*

Abstract—Recently we reported design approaches for the synthesis of multi-SQUID structures capable of providing high linearity voltage response. These structures were developed to form periodic voltage responses. This paper presents possible design solutions for multi-element structures providing SQIF-like high linearity voltage response. The approach is based on the use of a differential scheme of two parallel SQIFs with arrays oppositely frustrated by applied magnetic field δB . The differential scheme enables a high efficiency synthesis of highly linear SQIF response by subtraction of deviations from linear law.

Index Terms— SQUID arrays, parallel SQIF, differential scheme, amplifiers, high linearity, dynamic range.

I. INTRODUCTION

RECENTLY we have reported an approach to the synthesis of multi-SQUID structures capable of providing high linearity voltage response [1],[2]. The approach is based on the formation of serial structures capable of providing periodic triangular voltage response to a homogeneous magnetic field B with “frequency” spectrum as follows:

$$V(B) = \sum_k A_k \cos(k\omega_0 B), \quad A_k = A_0 \sum_k \frac{\sin^2(k\omega_0 \Delta B / 2)}{(k\omega_0 \Delta B / 2)^2}, \quad (1)$$

where $2\Delta B$ is width of the triangular pulse with repetition cycle $B_T = 2\pi/\omega_0$. Two ways were suggested for the structure formation. The first one is to use interferometer cells (dc SQUIDs) providing harmonic voltage response with “frequency” $k\omega_0 = (2\pi/\Phi_0) \cdot a_k$, where a_k is effective area of the interferometer cell which belongs to the k -th group. In case when input signal is a control line current I (instead of B), the effective area should be replaced by mutual inductance M_k , i. e. $k\omega_0 = (2\pi/\Phi_0) \cdot M_k$.

It is significant that spectrum of the voltage response with minimum period $B_T = 2\Delta B$ contains only odd harmonics with amplitudes decreasing monotonically as the squared harmonic number:

$$A(k\omega_0) = A_0/k^2, \quad k = 2n-1, \quad n = 1, 2, \dots \quad (2)$$

The second way is to form a differential scheme using serial arrays of interferometer cells biased by current $I_b = I_C$, where I_C is the interferometer critical current. Voltage response of such an array is characterized by numerous harmonics with monotonically decreasing amplitudes:

$$A(n\omega_0) = \frac{A_0}{n^2 - 1}. \quad (3)$$

Apart from a few first harmonics, the amplitude decrease law is quite close to $1/n^2$. Differential scheme of two serial arrays with $\Phi_0/2$ -frustration provides subtraction of all even harmonics, and therefore the resulting response becomes close enough to the triangular one with $B_T = \Delta B$. Fig. 1 shows schematically the differential array structure and magnetic biasing of the arrays. One can increase the linearity of the differential array voltage response. For this purpose, we should add to the array structure a few cells with sinusoidal responses generating necessary spectrum tones. These cells are dc interferometer biased well above critical current ($I_b > 2I_C$) in order to generate as close to a sinewave as possible. These additional cells are to correct the initial spectral components in (3) in order to approach the desired spectrum (2).

Now, we replace the individual interferometer cells in both serial arrays by parallel arrays and arrive to a *parallel-series differential structure*. In this paper we present further development of such a differential structure. Considerable increase in the voltage response linearity results from the use

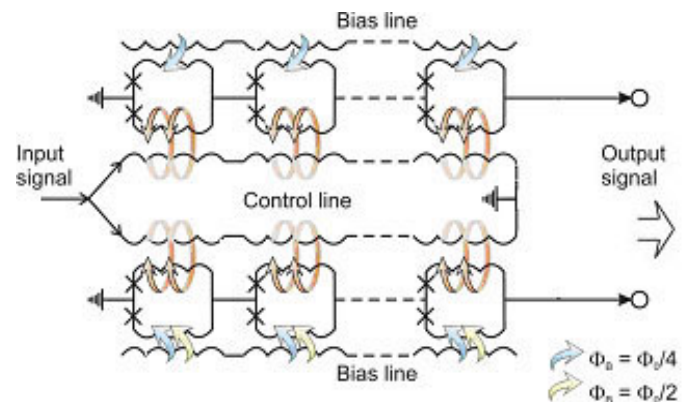

Fig. 1. Differential array structure consisting of two series arrays of dc interferometers with biasing $I_b = I_C$, where I_C – critical current of the interferometers. In one array, each cell is biased by magnetic flux $\Phi_0/2$. Additional flux $\Phi_0/4$ is applied to all cells to set the operating point.

Manuscript received 19 August 2008. This work was supported by ONR under grant RUP1-1493-05-MO via CRDF GAP and in part by ISTC grant 3743 and Russian grants on scientific schools PGSS 5408.2008.2 and PGSS 133.2008.2.

V. K. Kornev, I. I. Soloviev, N. V. Klenov are with Moscow State University, Moscow 119991, Russia. (phone: 7-495-939-4351, fax: 7-495-939-3000, e-mail: kornev@phys.msu.ru).

O. A. Mukhanov is with the HYPRES, 175 Clearbrook Road, Elmsford, NY 10523, USA (e-mail: mukhanov@hypres.com).

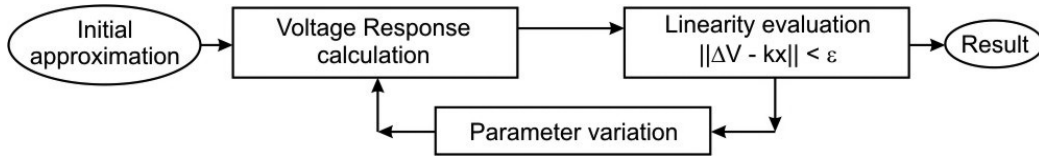

Fig. 2. Iterative algorithm for finding an optimal SQIF area distribution $a(x)$.

of parallel SQIFs [3] with synthesized array structure instead of ordinary parallel arrays with randomly chosen parameters.

II. SQIF-BASED DIFFERENTIAL STRUCTURES

A. Optimal Cell Area Distribution

Differential scheme of two parallel SQIFs oppositely frustrated by an applied magnetic field δB (see Fig. 3) is able to provide extremely linear voltage response in case of properly synthesized SQIF structure. At vanishing inductances l of the interferometer cells one can use analytical relation for the parallel SQIF response [3]-[5]:

$$V(B) = V_c \sqrt{(I_b / I_c)^2 - |S_K(B)|^2} \quad (4)$$

where $S_K(B)$ is structural factor:

$$S_K(B) = \frac{1}{K} \sum_{k=1}^K \exp\left(i \frac{2\pi}{\Phi_0} B \sum_{m=1}^{k-1} a_m\right), \quad (5)$$

I_b – bias current, I_c – total critical current, K – number of Josephson junctions, a_m – area of the m -th interferometer cell. At sufficiently high number K one can use integration instead of summation, and relation (5) can be transformed as follows:

$$S(B) = \frac{1}{L} \int_0^L dz \cdot \exp\left(i \frac{2\pi}{\Phi_0} B \int_0^z a(x) dx\right). \quad (6)$$

We need to find the specific distribution of the interferometer cell areas $a(x)$ along SQIF-structure ($0 < x < L$) to make the differential circuit voltage response

$$\Delta V(B) = V(B + \delta B) - V(B - \delta B) \quad (7)$$

close to a linear law

$$\Delta V(B) = k \cdot B \quad (8)$$

in a signal region $-\alpha \cdot \delta B < B < \alpha \cdot \delta B$, where $\alpha \leq 1$.

Relations (2)-(6) allow deriving master equations and stating minimization problem for the obtained functional in order to find an optimal distribution $a(x)$. One can use an iterative algorithm to find the problem solution, starting from some initial approximation (Fig. 2). In case of finite inductances l of the interferometer cells, the SQIF response

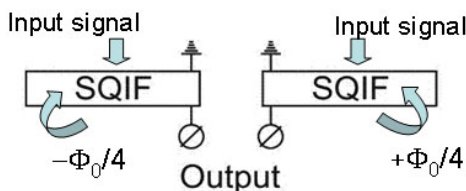

Fig. 3. Differential scheme of two parallel SQIFs frustrated by $\Phi_0/2$.

$V(B)$ has to be calculated by means of numerical simulation, using, e.g. PSCAN simulation package [6].

The problem can have more than one solution. We have found some analytical approximations for solutions at $l = 0$; the best one is shown below:

$$a(x)/a_\Sigma = 1.2 - 0.48 \sin^3(\pi x), \quad (9)$$

where a_Σ – total area of SQIF.

B. Response Linearity

Fig. 4 shows both the cell area distribution (9) and the differential circuit voltage response. The linearity of the voltage response within the shaded central area reaches 101 dB. To estimate the linearity, we applied *sin*-like input signal and then studied spectrum of output signal. The ratio of the fundamental to the highest spur was used to characterize the response linearity. It was found that the high linearity can be obtained using relatively small number N of SQIF cells with the cell areas fitted to (9). Fig. 5a shows that the linearity increases rapidly with number N and at $N > 35$ reaches a

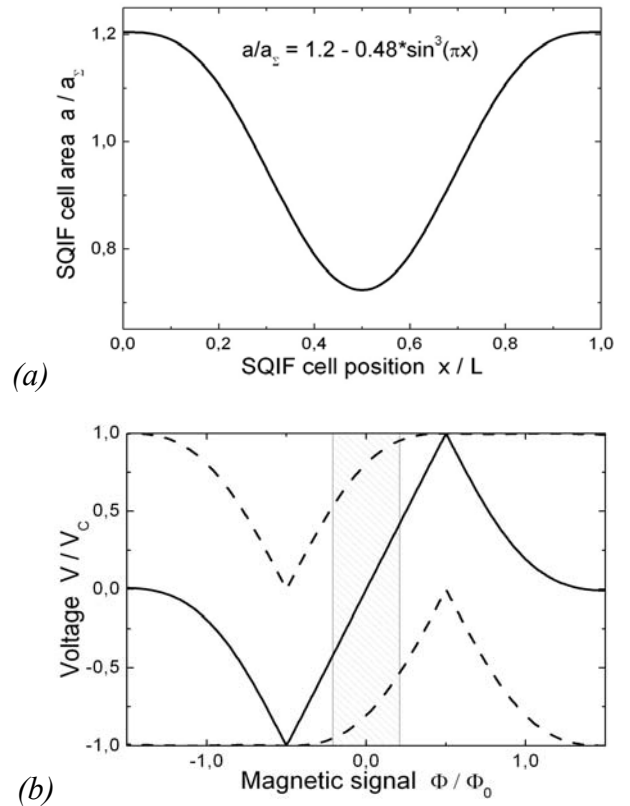

Fig. 4. (a) The derived optimal distribution (9) of the cell areas along SQIF structure. (b) Voltage response (solid line) of the differential circuit of two parallel SQIFs with the derived cell area distribution at optimal magnetic frustration. The response linearity within the shaded central area reaches 101 dB. The frustrated SQIF responses are shown by dashed lines.

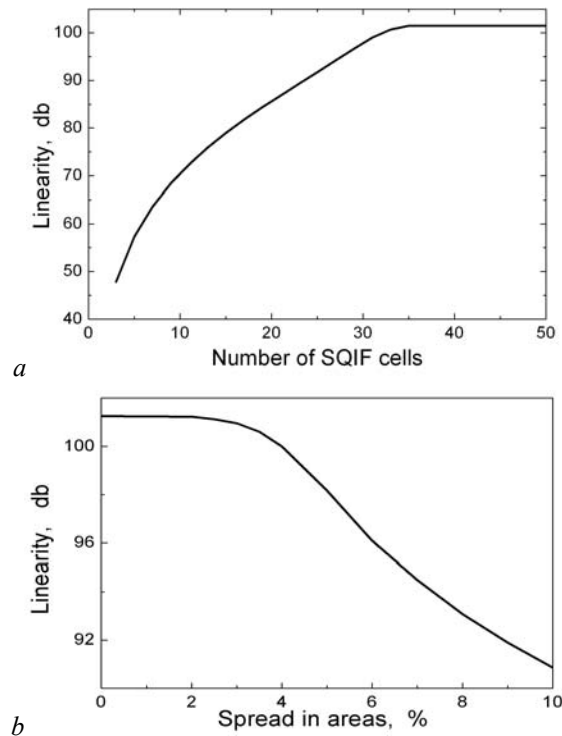

Fig. 4. Linearity of the differential voltage response versus both the number N of SQIF cells (a) and the spread in the cell areas at $N = 36$ (b).

plateau where the linearity is about 101 dB. As for the impact of fabrication spread in the cell areas, Fig. 5b shows that the tolerable spread is about 4% at $N = 36$; and then the linearity decreases with the spread value. Approximately the same result was obtained for spread in critical currents of Josephson junctions. Larger number of N can be used in order to decrease impact of the fabrication spread in the SQIF circuit parameters as well as to increase dynamic range proportional to \sqrt{N} up to the linearity level obtained.

C. Two-Dimensional Structure

Both the dynamic range and the output signal amplitude can be additionally increased by connection of the differential SQIF structures in series, i.e. by integrating a two-dimensional differential serial-parallel SQIF structure (see Fig. 5). The number K of the elements connected in series is responsible for the output signal amplitude, while total number of Josephson junctions $N^* = N \cdot K$ is responsible for dynamic range of the structure. Varying the number of

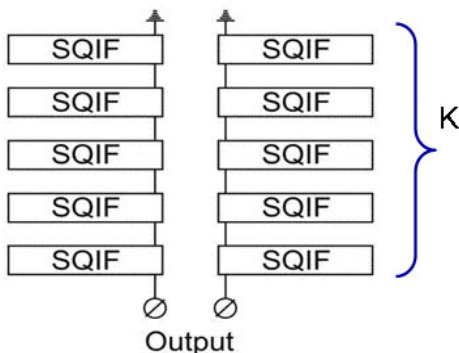

Fig. 5. Two-dimensional differential serial-parallel SQIF structure.

elements connected in parallel (N) and in series (K), one can change impedance of the structure in wide range.

III. INDUCTANCE INFLUENCE

A. From Model to Real Structure

There are several problems which should be solved in order to realize the potentially high performance of two-dimensional SQIF structures. One should note that the optimally synthesized structure of parallel SQIF was derived using the RSJ model of Josephson junctions and also assuming vanishing coupling inductances ($L = 0$). This means that the performance of real SQIF structures will likely to be lower. One can suggest three approaches of preserving the expected high performance: (i) to provide the closest approach of the experimental Josephson junction characteristics to the ones given by RSJ model, (ii) to synthesize an optimal SQIF structure based on experimental Josephson junction characteristics and unavoidable circuit parasitics using numerical simulation technique and iterative algorithm (Fig. 2), and (iii) to utilize circuit techniques to minimize impact of parasitic parameters to the overall circuit performance. In all probability, an optimal strategy should be based on combination of all these approaches.

B. Shunting of Coupling Inductances

In particular, in order to minimize the negative influence of the finite value of coupling inductance L to the voltage response linearity, one can use shunting resistors R_{SH} connected in parallel to these inductances. Due to the fact that impedance of the RL circuit becomes low enough at Josephson oscillation frequency, the parallel array voltage response approaches the one for smaller and smaller inductance with decreasing R_{SH} down to some optimal resistance value depending on the normalized inductance l . The further increase in R_{SH} leads to some other linearity distortions. Therefore the most efficient way is the synthesis of an optimal SQIF structure with the cell area distribution $a(x)$ taking into account realistic finite values of l found from the circuit layout. In this case, one should use a high performance numerical simulation technique (e.g., PSCAN [6]) for calculation of the SQIF voltage response $V(\Phi)$ in every cycle of the iterative algorithm (Fig. 2) which is to be used to solve master equation.

The shunting technique utility is confirmed by the results of numerical simulations presented in Fig. 6. One can see that at $R_{SH} \approx 0.1R_N$ (where R_N is Josephson junction normal resistance) voltage response of the parallel array of 6 junctions with $l \equiv 2\pi I_C L / \Phi_0 = 1$ nears to the one at vanishing coupling inductances. As a consequence, we observe the required linear voltage response of the differential scheme of two parallel SQIFs with $N = 20$ and coupling inductances $l = 1$ each shunted by resistor $R_{SH} = 0.1R_N$.

IV. CONCLUSIONS

The differential scheme of two magnetically frustrated parallel SQIFs is developed to obtain highly linear single-peak voltage response. The response linearity can be increased up to 120 dB by finding the optimal SQIF cell area distribution using numerical simulations with realistic circuit parameters.

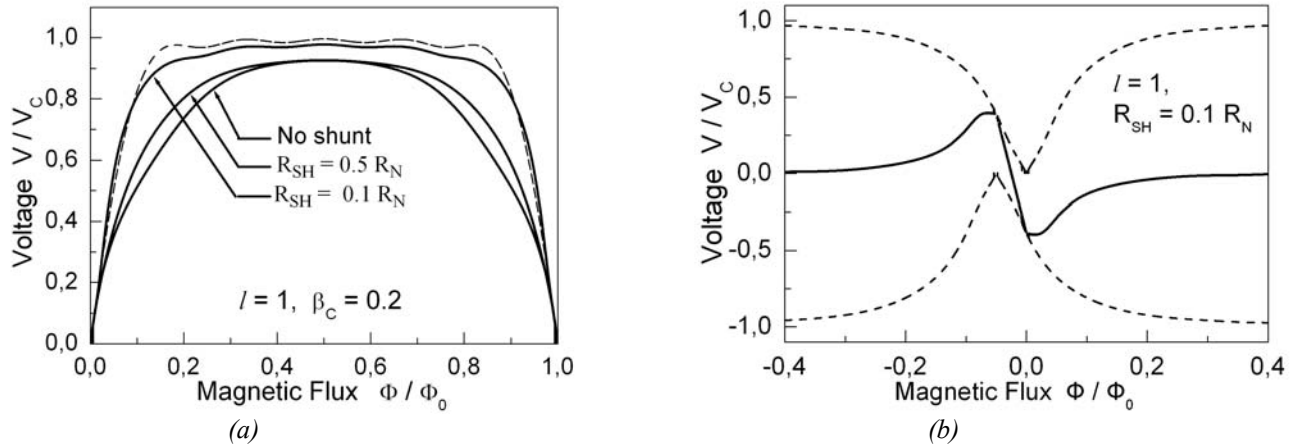

Fig. 6. (a) Voltage response of a parallel array of $N = 6$ junctions coupled by inductances with normalized value $l = 1$ at different shunting resistors R_{sh} connected in parallel to the coupling inductances. Dash line shows voltage response of the array at the vanishing coupling inductance. (b) Voltage response of the differential circuit of two frustrated parallel arrays of $N = 6$ Josephson junctions at $l = 1$ and $R_{sh} = R_N$, where R_N – Josephson junction normal resistance.

High linearity can be attainable for relatively small number of junctions. Such a circuit allows us to achieve high-performance in a two-dimensional serial-parallel SQIF-like array. Varying the number of elements connected in parallel and in series, one can set the impedance value needed to minimize the negative impact of the load. The synthesized structures can be used to design high-performance amplifiers and electrically small active antennas for megahertz and gigahertz frequency ranges.

ACKNOWLEDGMENT

Authors thank Alex Kirichenko and Henrik Engseth for valuable help and discussion.

REFERENCES

- [1] V. K. Kornev, I. I. Soloviev, N. V. Klenov, and O. A. Mukhanov, "Synthesis of high linearity array structures," *Superconducting Science and Technology*, vol. 20, pp. S362-S366, 2007.
- [2] V. K. Kornev, I. I. Soloviev, N. V. Klenov, and O. A. Mukhanov, "High linearity Josephson-junction array structures," *Physica C*, vol. 468, pp. 813-816, 2008.
- [3] J. Oppenlaender, Ch. Haeussler, and N. Schopohl, "Non- Φ_0 -periodic macroscopic quantum interference in one-dimensional parallel Josephson junction arrays with unconventional grating structure," *Phys. Rev. B*, vol. 63, pp. 024511-1-9, 2001.
- [4] V. Schultze, R. I. Jsselsteijn, H.-G. Meyer, J. Oppenländer, Ch. Häussler, and N. Schopohl, "High- T_c superconducting quantum interference filters for sensitive magnetometers," *IEEE Trans. Appl. Supercond.*, vol. 13, no. 2, pp. 775-778, 2003.
- [5] V. K. Kornev, I. I. Soloviev, J. Oppenlaender, Ch. Haeussler, N. Schopohl, "Oscillation linewidth and noise characteristics of parallel SQIF," *Superconductor Science and Technology*, vol. 17, Issue 5, pp. S406 - S409, 2004.
- [6] V. K. Kornev, A. V. Arzumanov, "Numerical simulation of Josephson-junction system dynamics in the presence of thermal noise," *Inst. Physics Conf. Ser.*, IOP Publishing Ltd, no 158, pp. 627-630, 1997.